

### H4 PV Cable Connector

H4 Female Cable Connector

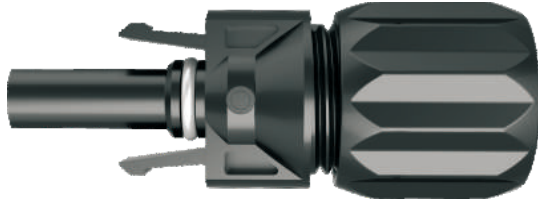

H4 Male Cable Connector



H4 Cold Formed Contact

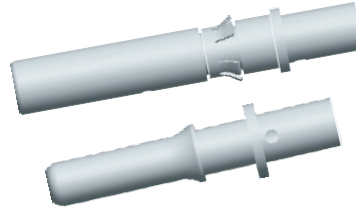

H4 Stamped and Formed Contact

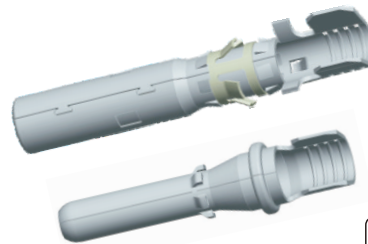

### Features & Benefits

- UL 6703, 1500V DC & TUV 62852, 1000V DC, and CSA approved
- Long-term UV resistance
- High current rating in industry
- RoHS, REACH, Halogen-free compliant
- Low contact resistance means low loss

### Technical Specification



R 50388083



E 339277



250535

Rated Voltage	UL	1500V DC per UL 6703
	TUV	1000V DC per IEC 62852, Class A Unrestricted Use
Rated Current(IEC85°C)	25A ( 2.5mm <sup>2</sup> /14AWG), 35A ( 4.0mm <sup>2</sup> / 12AWG), 45A (6.0mm <sup>2</sup> /10AWG) ,65A ( 10mm <sup>2</sup> / 8AWG)	
Rated Current(UL)	15A ( 2.5mm <sup>2</sup> /14AWG), 20A ( 4.0mm <sup>2</sup> / 12AWG), 30A (6.0mm <sup>2</sup> /10AWG) ,50A ( 10mm <sup>2</sup> / 8AWG)	
Rated Insulation Voltage	6kV for 1 minute(IEC)	
Rated impulse voltage	12kV (IEC)	
Contact System Options	Stamped and Formed (S&F) / Cold Formed (CF) contact, both with Amphenol's RADSOK® Insert	
Typical contract resistance	≤0.30mΩ for S&F contact, ≤0.25mΩ for CF contact, using Amphenol's low resistance RADSOK® contact technology	
Insulation material	Thermoplastic	
Contact Material	Tin-Plated Copper Alloy.	
Locking Mechanism	Meets 2014 NEC handbook 690.33(C), requirement for self-locking with tool-required unlock.	
Ingress Protection Ratings	IP68(1 meter, 1 hour) mated & IP2X touch-proof (reverse gender design)	
Flammability Classification	UL94, V-0	
Jacket of Cable Range	Ø4.5mm~Ø7.8mm	
Pollution Degree	2	
Over Voltage Category	CAT III	
Safety Class	Class II	
Ambient Temperature	-40°C to +85°C	
Upper Limiting	120°C	
RoHS and Halogen Free	Compliance	
UV Resistance	Outdoor suitable (f1) rated materials, per UL 746C	

### Assembly Tool:



Tool-kit H4TK0000



Unlock Tool H4TU0000



Wrench Tool H4TW0001



Strip Tool H4TS0000



Crimp Tool for S&F contact H4TC0002 for C&F contact H4TC0001



New Crimp Tool for S&F contact H4TC0003 for C&F contact UTXTC0004



Inspection Tool H4TT0001

#### NOTES:

\* THIS DOCUMENT CONTAINS PROPRIETARY INFORMATION AND SUCH INFORMATION MAY NOT BE DISCLOSED TO OTHERS FOR ANY PURPOSE OR USED FOR MANUFACTURING PURPOSES WITHOUT WRITTEN PERMISSION FROM THE AMPHENOL CORP.

www.amphenol-solar.com

#### ASIA

**Amphenol Technology (Shenzhen) Co., Ltd.**  
Building C, 2nd Industrial Zone of Xia Shi Jia  
Gongming Sub-district, Guangming New district  
Shenzhen, China 518106  
Tel: +86-755-29918389

#### NORTH AMERICA

**Amphenol Industrial Operations**  
191 Delaware Avenue  
Sidney, New York 13838-1395 USA  
Tel: +1-888-364-9011  
**Amphenol Industrial Solar Technologies**  
180N Freeport DR.W-10, Nogales AZ 85621-2423  
Tel: +1-520-397-7047

#### EUROPE & THE MIDDLE EAST

**Amphenol Industrial Operations Europe**  
Via Barbaiana 51-20020 Lainate (MI) Italy  
Tel: +39-348-3145390  
**Amphenol Industrial Operations Middle East**  
Office C-37 PO Box 21107  
Ajman Free Zone, UAE  
Tel: +39-348-3145390

### H4 PV Cable Connector

#### Product Dimensions

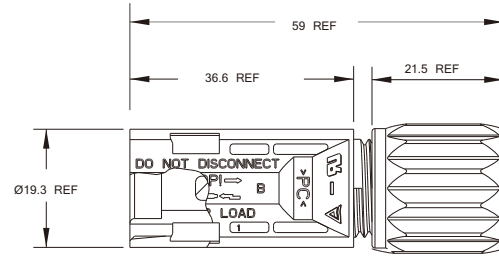
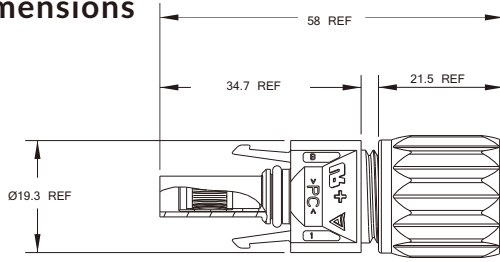

H4 Stamped and Formed Contact

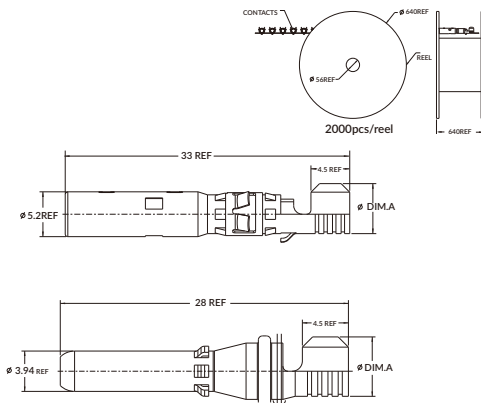

H4 Cold Formed Contact

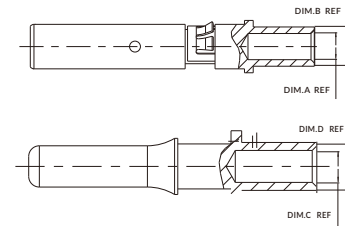

Accept wire conductor size mm <sup>2</sup> (AWG)	"A"
2.5(14)	4.80
4&6(12&10)	5.80

Accept wire conductor size mm <sup>2</sup> (AWG)	"A"	"B"	"C"	"D"
2.5(14)	2.30	3.5	2.3	3.5
4.0(12)	3.05	4.57	3.05	4.57
4&6(12&10)	3.4	4.6	3.4	4.6
6.0(10)	3.7	6.00	3.7	6.00
10.0(8)	4.5	6.00	4.5	6.00

#### How to Order

How to order a connector (Please choose one code per position)

Product family	Product Type	Gender	Connector Type	Cable Size	Approvals
H4 Helios H4	C Connector	F Female M Male	C Cable gland	2 2.5mm <sup>2</sup> /14 AWG 4 4.0mm <sup>2</sup> /12 AWG& 6.0mm <sup>2</sup> /10 AWG (S&F) 4.0mm <sup>2</sup> /12 AWG (CF) 6 6.0mm <sup>2</sup> /10 AWG (CF) 8 10.0mm <sup>2</sup> /8 AWG (CF) 0 Less contacts	D Dual TUV/UL Certified
<b>Packaging</b>		<b>Contact</b>			
I 1pcs/bag, 800pcs/box C 100pcs/bag, 10 bags/box M 500pcs/bag, 2 bags/box		S S&F Contact Blank CF Contact			

#### Order Example:

H4CFC4DMS: H4 cable connector, female, 4.0mm<sup>2</sup>/12 AWG & 6.0mm<sup>2</sup>/10 AWG S&F contact, 1000pcs per box  
H4CFC4DM: H4 cable connector, female, 4.0mm<sup>2</sup>/12 AWG CF contact, 1000pcs per box

How to order S&F Contacts on Reels (Please choose one code per position)

Product family	Contact Type	Gender	Cable Size	Packing
H4 Helios H4	F S&F contact	F Female M Male	2 1.5mm <sup>2</sup> /16 AWG&2.5mm <sup>2</sup> /14 AWG 4 4.0mm <sup>2</sup> /12 AWG&6.0mm <sup>2</sup> /10 AWG	R 2000pcs/reel

Note: If ordering contacts in 2000pcs/reel version, need to order contact and plastic housing separately. contact ordering code refers to this table.

#### Order Example:

H4CFC0DM: H4 Cable connector, Female, housing assembly, 1pcs.  
H4CMC0TM: H4 Cable connector, Male, housing assembly, 1 pcs.  
H4FF4R: H4 female contact on reel, 4.0mm<sup>2</sup>/12 AWG & 6.0mm<sup>2</sup>/10 AWG , 2000pcs/reel.  
H4FM2R: H4 male contact on reel, 2.5mm<sup>2</sup>/14 AWG , 2000pcs/reel.

#### NOTES:

\* THIS DOCUMENT CONTAINS PROPRIETARY INFORMATION AND SUCH INFORMATION MAY NOT BE DISCLOSED TO OTHERS FOR ANY PURPOSE OR USED FOR MANUFACTURING PURPOSES WITHOUT WRITTEN PERMISSION FROM THE AMPHENOL CORP.

#### ASIA

#### NORTH AMERICA

#### EUROPE & THE MIDDLE EAST